

Service  
Service  
Service



# Service Manual

TABLE OF CONTENTS	Page
Specifications	2
Connections and controls	3
Schematic diagrams	4,5,8,10,11,12
Wiring diagrams	7,8,9,13,14,15
Adjustments, standard symbol list	16
Semi-conductor layout	17
Mechanical parts list	18
Exploded view	19,20,21,22,23,24
Electrical parts list	25





# SI

Wichtig für die Werkstatt!

Nummer: 20341

Datum: 21.04.88 De/Li

Bereich: HIF1 AC 21

Service Information

Betrifft: High Tech-Verstärker TE FA 800  
Änderungen

Verleiher: intern und extern

1.  
In Geräten mit Seriennummer ab 030001 sind die Ferritkerne über den Anschlussdrähten der Widerstände R 403, R 404, R 407 und R 408 entfallen; stattdessen sind in die Phonoeingänge 2 Drosselspulen eingefügt worden ( s. Fig. 1 ) :

L 401	320 µH	4022 156 11019
		eingefügt zwischen J 403 (L) und
		Verbindungspunkt R 401/R403
L 402	320 µH	4022 156 11019
		eingefügt zwischen J 403 (R) und
		Verbindungspunkt R402/R404

2.  
Zur Verkürzung der Einschalt-Versögerung ist in Geräten mit Seriennummer ab 40001 der Widerstand R8 15 (200 k) geändert worden in 120 k.

3.  
Zur Erhöhung der Betriebssicherheit werden in Geräten mit Seriennummer ab 12001 die Widerstände R 802 und R 803 durch gleiche Werte einer anderen Bauart ersetzt.

R 802, R 803	10 Ω, 0.25 W	4022 116 60314
--------------	--------------	----------------

4.  
Zur Erhöhung der Lampchen-Lebensdauer sind in Geräten mit Seriennummer ab 140001 folgende Änderungen eingeführt worden:

- R 807 (100 Ω) entfallen
- Connector J 805 entfallen
- Connector J 809 auf Print P 801 hinzugefügt; die Lampenzuleitung W2 01 ist bei J 809 angeschlossen (s. Fig. 2.3).

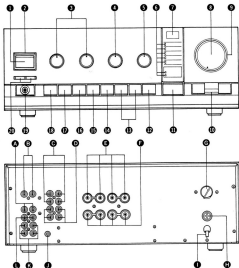

#### CONNECTIONS AND CONTROLS

1	Main switch	S501	A	CD input	JV01
2	Main switch illumination	V251	B	Phono input	J403
3	Tone control	RE55, RE66	C	Tape 1 monitor input/output	J801
4	Rec. output selector switch	S502, S503	D	Tape 2 monitor input/output	J802
5	Function switch	S501, S501	E	LS output A	J701, J702
6	Function indicator	GY51-GY53	F	LS output B	
7	CD direct indicator	YY51	G	Voltage selector (D/F version only)	J051
8	Volume control	RQ55	H	Fuse holder	J051
9	Volume control illumination	V251, V252	I	Mains cord	W001
10	Balance control	RG51	J	Ground terminal	J053
11	CD direct switch	S503	K	Aux 1/TV, Aux 2/1V input	Jv00
12	Phono MM/MC switch		L	Tuner input	
13	Tape copy switch	S502			
14	Tape monitor 2 switch				
15	Tape monitor 1 switch				
16	Mute switch	S501			
17	Tone defeat switch				
18	Loudness switch				
19	Headphone socket	JW51			
20	LS switch	ST01			

SPECIFICATION	Nominal values	Typical value
<b>General</b>		
Mains voltage	: 220V ~ Service selection for 220V - 240V	: 220V ~ Service selection for 110V - 120V - 220V - 240V
Mains frequency	: 50 - 60 Hz	: 50 - 60 Hz
Power consumption	: 350W at rated power	: 450W at rated power
Dimensions (WxHxD)	: 420 x 148 x 334 mm	: 415 x 148 x 334 mm
Weight	: 14 kg	: 14 kg
<b>Amplifier</b>		
Output power	: 100W in 6Ω (FTC) D < 0.03% 130W in 8Ω (IEC)	: 100W in 6Ω (FTC) D < 0.03% 130W in 8Ω (IEC)
Power bandwidth (60)-3 dB of rated power	: 15 Hz - 25 kHz D < 0.03%	: 10 Hz - 20 kHz D < 0.03%
Distortion		
T.H.D.	: < 0.008% at 1 kHz < 0.3% at 40 Hz - 10 kHz < 0.03% at 60/1000 Hz 4:1 (IEC)	: < 0.008% at 1 kHz < 0.03% at 40 Hz - 10 kHz < 0.03% at 60/1000 Hz 4:1 (IEC)
Intermodulation		
Frequency characteristics		
Phono input	tone defect	: from 20 Hz - 20 kHz ±0.5 dB (IEC)
Other inputs		: from 20 Hz - 20 kHz ±0.5 dB
Bass control		: at 100 Hz ±10 dB to -10 dB ±2 dB
Treble control		: at 10 kHz ±10 dB to -10 dB ±2 dB
Loudness		: at 100 Hz +6 dB ±1.5 dB at 10 kHz +4 dB ±1.5 dB   Tap position
Phono overload		
MM	: 100 mV at 1 kHz	: 150 mV at 1 kHz
MC	: 10 mV at 1 kHz	: 10 mV at 1 kHz
Signal/noise ratio weighted (A-curve)		
Phono input	: for 1W output ≥ 80 dB (IEC)	: for 1W output ≥ 80 dB (IEC)
Other inputs	: for 1W output ≥ 88 dB (IEC)	: for 1W output ≥ 88 dB (IEC)
Channel separation	: at 1000 Hz ≥ 70 dB at 250 Hz - 10 kHz ≥ 58 dB	: at 1000 Hz ≥ 70 dB at 250 Hz - 10 kHz ≥ 68 dB
<b>Input sensitivity</b>		
Phono MC	: 0.25 mV at 100Ω	: 0.25 mV at 100Ω
Phono MM	: 2.5 mV at 47 kΩ	: 2.5 mV at 47 kΩ
Linear inputs	: 150 mV at 20 kΩ	: 150 mV at 20 kΩ
<b>Outputs (Phono MM 7.75 mV 1 kHz input)</b>		
Tape	: 465 mV ± 90 mV at 220Ω	: 465 mV at 220Ω
Damping factor (60)	: 120 at 20 Hz : 90 at 10 kHz	: 120 at 20 Hz : 100 at 10 kHz

### Caution ⚡ 220 V/240 V

Removal of upper cabinet exposes the protruding current-carrying parts of mains switch and mains transformer, therefore extreme care should be taken when the apparatus is connected to the mains.

### Unracking instructions

See for the unracking instructions exploded view on page 19 - 24.

NO.	WIRING										PAGE
	1	2	3	4	5	6	7	8	9	10	
1	1000 - 1000										1000 1000
2	1000 1000										1000 1000
3 - 10 - 1											1000
4 - 1											1000

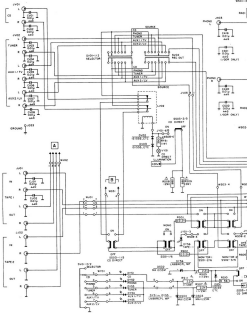

# SCHEMATIC DIAGRAM

RADIO SECTION		MOTOR SECTION				MOTOR SECTION		MOTOR SECTION		MOTOR SECTION	
WIRING POINT	WIRING POINT	WIRING POINT	WIRING POINT	WIRING POINT	WIRING POINT	WIRING POINT	WIRING POINT	WIRING POINT	WIRING POINT	WIRING POINT	
101	102	103	104	105	106	107	108	109	110	111	
112	113	114	115	116	117	118	119	120	121	122	
123	124	125	126	127	128	129	130	131	132	133	
134	135	136	137	138	139	140	141	142	143	144	
145	146	147	148	149	150	151	152	153	154	155	
156	157	158	159	160	161	162	163	164	165	166	
167	168	169	170	171	172	173	174	175	176	177	
178	179	180	181	182	183	184	185	186	187	188	
189	190	191	192	193	194	195	196	197	198	199	
200	201	202	203	204	205	206	207	208	209	210	

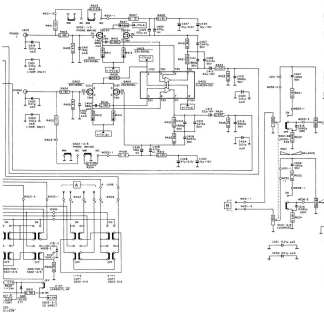

1000	1001	1002	1003	1004	1005	1006	1007	1008	1009	1010	1011	1012	1013	1014	1015	1016	1017	1018	1019	1020	1021	1022	1023	1024	1025	1026	1027	1028	1029	1030	1031	1032	1033	1034	1035	1036	1037	1038	1039	1040	1041	1042	1043	1044	1045	1046	1047	1048	1049	1050	1051	1052	1053	1054	1055	1056	1057	1058	1059	1060	1061	1062	1063	1064	1065	1066	1067	1068	1069	1070	1071	1072	1073	1074	1075	1076	1077	1078	1079	1080	1081	1082	1083	1084	1085	1086	1087	1088	1089	1090	1091	1092	1093	1094	1095	1096	1097	1098	1099	1100
1101	1102	1103	1104	1105	1106	1107	1108	1109	1110	1111	1112	1113	1114	1115	1116	1117	1118	1119	1120	1121	1122	1123	1124	1125	1126	1127	1128	1129	1130	1131	1132	1133	1134	1135	1136	1137	1138	1139	1140	1141	1142	1143	1144	1145	1146	1147	1148	1149	1150	1151	1152	1153	1154	1155	1156	1157	1158	1159	1160	1161	1162	1163	1164	1165	1166	1167	1168	1169	1170	1171	1172	1173	1174	1175	1176	1177	1178	1179	1180	1181	1182	1183	1184	1185	1186	1187	1188	1189	1190	1191	1192	1193	1194	1195	1196	1197	1198	1199	1200	
1201	1202	1203	1204	1205	1206	1207	1208	1209	1210	1211	1212	1213	1214	1215	1216	1217	1218	1219	1220	1221	1222	1223	1224	1225	1226	1227	1228	1229	1230	1231	1232	1233	1234	1235	1236	1237	1238	1239	1240	1241	1242	1243	1244	1245	1246	1247	1248	1249	1250	1251	1252	1253	1254	1255	1256	1257	1258	1259	1260	1261	1262	1263	1264	1265	1266	1267	1268	1269	1270	1271	1272	1273	1274	1275	1276	1277	1278	1279	1280	1281	1282	1283	1284	1285	1286	1287	1288	1289	1290	1291	1292	1293	1294	1295	1296	1297	1298	1299	1300	
1301	1302	1303	1304	1305	1306	1307	1308	1309	1310	1311	1312	1313	1314	1315	1316	1317	1318	1319	1320	1321	1322	1323	1324	1325	1326	1327	1328	1329	1330	1331	1332	1333	1334	1335	1336	1337	1338	1339	1340	1341	1342	1343	1344	1345	1346	1347	1348	1349	1350	1351	1352	1353	1354	1355	1356	1357	1358	1359	1360	1361	1362	1363	1364	1365	1366	1367	1368	1369	1370	1371	1372	1373	1374	1375	1376	1377	1378	1379	1380	1381	1382	1383	1384	1385	1386	1387	1388	1389	1390	1391	1392	1393	1394	1395	1396	1397	1398	1399	1400	

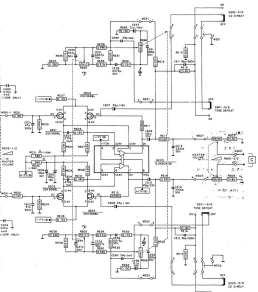





WIRING DIAGRAM

0000	0001	0002	0003	0004	0005	0006	0007	0008	0009	0010	0011	0012	0013	0014	0015	0016	0017	0018	0019	0020	0021	0022	0023	0024	0025	0026	0027	0028	0029	0030	0031	0032	0033	0034	0035	0036	0037	0038	0039	0040	0041	0042	0043	0044	0045	0046	0047	0048	0049	0050	0051	0052	0053	0054	0055	0056	0057	0058	0059	0060	0061	0062	0063	0064	0065	0066	0067	0068	0069	0070	0071	0072	0073	0074	0075	0076	0077	0078	0079	0080	0081	0082	0083	0084	0085	0086	0087	0088	0089	0090	0091	0092	0093	0094	0095	0096	0097	0098	0099
------	------	------	------	------	------	------	------	------	------	------	------	------	------	------	------	------	------	------	------	------	------	------	------	------	------	------	------	------	------	------	------	------	------	------	------	------	------	------	------	------	------	------	------	------	------	------	------	------	------	------	------	------	------	------	------	------	------	------	------	------	------	------	------	------	------	------	------	------	------	------	------	------	------	------	------	------	------	------	------	------	------	------	------	------	------	------	------	------	------	------	------	------	------	------	------	------	------	------	------

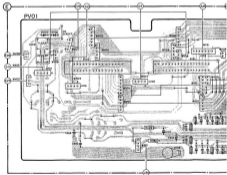
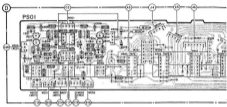
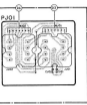

## WIRING DIAGRAM

14 1401 1402 1403 1404 1405 1406 1407 1408 1409 1410 1411	1412 1413 1414 1415 1416 1417 1418 1419 1420 1421 1422 1423 1424 1425 1426 1427 1428 1429 1430 1431 1432 1433 1434 1435 1436 1437 1438 1439 1440 1441 1442 1443 1444 1445 1446 1447 1448 1449 1450 1451 1452 1453 1454 1455 1456 1457 1458 1459 1460 1461 1462 1463 1464 1465 1466 1467 1468 1469 1470 1471 1472 1473 1474 1475 1476 1477 1478 1479 1480 1481 1482 1483 1484 1485 1486 1487 1488 1489 1490 1491 1492 1493 1494 1495 1496 1497 1498 1499 1500
15 1501 1502 1503 1504 1505 1506 1507 1508 1509 1510 1511 1512 1513 1514 1515 1516 1517 1518 1519 1520 1521 1522 1523 1524 1525 1526 1527 1528 1529 1530 1531 1532 1533 1534 1535 1536 1537 1538 1539 1540 1541 1542 1543 1544 1545 1546 1547 1548 1549 1550 1551 1552 1553 1554 1555 1556 1557 1558 1559 1560 1561 1562 1563 1564 1565 1566 1567 1568 1569 1570 1571 1572 1573 1574 1575 1576 1577 1578 1579 1580 1581 1582 1583 1584 1585 1586 1587 1588 1589 1590 1591 1592 1593 1594 1595 1596 1597 1598 1599 1600	16 1601 1602 1603 1604 1605 1606 1607 1608 1609 1610 1611 1612 1613 1614 1615 1616 1617 1618 1619 1620 1621 1622 1623 1624 1625 1626 1627 1628 1629 1630 1631 1632 1633 1634 1635 1636 1637 1638 1639 1640 1641 1642 1643 1644 1645 1646 1647 1648 1649 1650 1651 1652 1653 1654 1655 1656 1657 1658 1659 1660 1661 1662 1663 1664 1665 1666 1667 1668 1669 1670 1671 1672 1673 1674 1675 1676 1677 1678 1679 1680 1681 1682 1683 1684 1685 1686 1687 1688 1689 1690 1691 1692 1693 1694 1695 1696 1697 1698 1699 1700
17 1701 1702 1703 1704 1705 1706 1707 1708 1709 1710 1711 1712 1713 1714 1715 1716 1717 1718 1719 1720 1721 1722 1723 1724 1725 1726 1727 1728 1729 1730 1731 1732 1733 1734 1735 1736 1737 1738 1739 1740 1741 1742 1743 1744 1745 1746 1747 1748 1749 1750 1751 1752 1753 1754 1755 1756 1757 1758 1759 1760 1761 1762 1763 1764 1765 1766 1767 1768 1769 1770 1771 1772 1773 1774 1775 1776 1777 1778 1779 1780 1781 1782 1783 1784 1785 1786 1787 1788 1789 1790 1791 1792 1793 1794 1795 1796 1797 1798 1799 1800	18 1801 1802 1803 1804 1805 1806 1807 1808 1809 1810 1811 1812 1813 1814 1815 1816 1817 1818 1819 1820 1821 1822 1823 1824 1825 1826 1827 1828 1829 1830 1831 1832 1833 1834 1835 1836 1837 1838 1839 1840 1841 1842 1843 1844 1845 1846 1847 1848 1849 1850 1851 1852 1853 1854 1855 1856 1857 1858 1859 1860 1861 1862 1863 1864 1865 1866 1867 1868 1869 1870 1871 1872 1873 1874 1875 1876 1877 1878 1879 1880 1881 1882 1883 1884 1885 1886 1887 1888 1889 1890 1891 1892 1893 1894 1895 1896 1897 1898 1899 1900
19 1901 1902 1903 1904 1905 1906 1907 1908 1909 1910 1911 1912 1913 1914 1915 1916 1917 1918 1919 1920 1921 1922 1923 1924 1925 1926 1927 1928 1929 1930 1931 1932 1933 1934 1935 1936 1937 1938 1939 1940 1941 1942 1943 1944 1945 1946 1947 1948 1949 1950 1951 1952 1953 1954 1955 1956 1957 1958 1959 1960 1961 1962 1963 1964 1965 1966 1967 1968 1969 1970 1971 1972 1973 1974 1975 1976 1977 1978 1979 1980 1981 1982 1983 1984 1985 1986 1987 1988 1989 1990 1991 1992 1993 1994 1995 1996 1997 1998 1999 2000	20 2001 2002 2003 2004 2005 2006 2007 2008 2009 2010 2011 2012 2013 2014 2015 2016 2017 2018 2019 2020 2021 2022 2023 2024 2025 2026 2027 2028 2029 2030 2031 2032 2033 2034 2035 2036 2037 2038 2039 2040 2041 2042 2043 2044 2045 2046 2047 2048 2049 2050 2051 2052 2053 2054 2055 2056 2057 2058 2059 2060 2061 2062 2063 2064 2065 2066 2067 2068 2069 2070 2071 2072 2073 2074 2075 2076 2077 2078 2079 2080 2081 2082 2083 2084 2085 2086 2087 2088 2089 2090 2091 2092 2093 2094 2095 2096 2097 2098 2099 2100

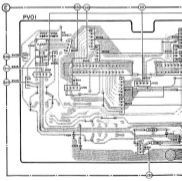
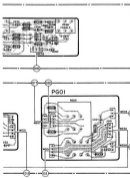
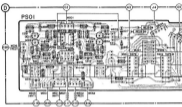
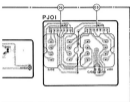

1000 1001 1002 1003 1004 1005 1006 1007 1008 1009 1010 1011 1012	1013 1014 1015 1016 1017 1018 1019 1020 1021 1022 1023 1024 1025	1026 1027 1028 1029 1030 1031 1032 1033 1034 1035 1036 1037 1038	1039 1040 1041 1042 1043 1044 1045 1046 1047 1048 1049 1050 1051	1052 1053 1054 1055 1056 1057 1058 1059 1060 1061 1062 1063 1064	1065 1066 1067 1068 1069 1070 1071 1072 1073 1074 1075 1076 1077	1078 1079 1080 1081 1082 1083 1084 1085 1086 1087 1088 1089 1090	1091 1092 1093 1094 1095 1096 1097 1098 1099 1100 1101 1102 1103	1104 1105 1106 1107 1108 1109 1110 1111 1112 1113 1114 1115 1116	1117 1118 1119 1120 1121 1122 1123 1124 1125 1126 1127 1128 1129	1130 1131 1132 1133 1134 1135 1136 1137 1138 1139 1140 1141 1142	1143 1144 1145 1146 1147 1148 1149 1150 1151 1152 1153 1154 1155	1156 1157 1158 1159 1160 1161 1162 1163 1164 1165 1166 1167 1168	1169 1170 1171 1172 1173 1174 1175 1176 1177 1178 1179 1180 1181	1182 1183 1184 1185 1186 1187 1188 1189 1190 1191 1192 1193 1194	1195 1196 1197 1198 1199 1200 1201 1202 1203 1204 1205 1206 1207	1208 1209 1210 1211 1212 1213 1214 1215 1216 1217 1218 1219 1220	1221 1222 1223 1224 1225 1226 1227 1228 1229 1230 1231 1232 1233	1234 1235 1236 1237 1238 1239 1240 1241 1242 1243 1244 1245 1246	1247 1248 1249 1250 1251 1252 1253 1254 1255 1256 1257 1258 1259	1260 1261 1262 1263 1264 1265 1266 1267 1268 1269 1270 1271 1272	1273 1274 1275 1276 1277 1278 1279 1280 1281 1282 1283 1284 1285	1286 1287 1288 1289 1290 1291 1292 1293 1294 1295 1296 1297 1298	1299 1300 1301 1302 1303 1304 1305 1306 1307 1308 1309 1310 1311	1312 1313 1314 1315 1316 1317 1318 1319 1320 1321 1322 1323 1324	1325 1326 1327 1328 1329 1330 1331 1332 1333 1334 1335 1336 1337	1338 1339 1340 1341 1342 1343 1344 1345 1346 1347 1348 1349 1350	1351 1352 1353 1354 1355 1356 1357 1358 1359 1360 1361 1362 1363	1364 1365 1366 1367 1368 1369 1370 1371 1372 1373 1374 1375 1376	1377 1378 1379 1380 1381 1382 1383 1384 1385 1386 1387 1388 1389	1390 1391 1392 1393 1394 1395 1396 1397 1398 1399 1400 1401 1402	1403 1404 1405 1406 1407 1408 1409 1410 1411 1412 1413 1414 1415	1416 1417 1418 1419 1420 1421 1422 1423 1424 1425 1426 1427 1428	1429 1430 1431 1432 1433 1434 1435 1436 1437 1438 1439 1440 1441	1442 1443 1444 1445 1446 1447 1448 1449 1450 1451 1452 1453 1454	1455 1456 1457 1458 1459 1460 1461 1462 1463 1464 1465 1466 1467	1468 1469 1470 1471 1472 1473 1474 1475 1476 1477 1478 1479 1480	1481 1482 1483 1484 1485 1486 1487 1488 1489 1490 1491 1492 1493	1494 1495 1496 1497 1498 1499 1500 1501 1502 1503 1504 1505 1506	1507 1508 1509 1510 1511 1512 1513 1514 1515 1516 1517 1518 1519	1520 1521 1522 1523 1524 1525 1526 1527 1528 1529 1530 1531 1532	1533 1534 1535 1536 1537 1538 1539 1540 1541 1542 1543 1544 1545	1546 1547 1548 1549 1550 1551 1552 1553 1554 1555 1556 1557 1558	1559 1560 1561 1562 1563 1564 1565 1566 1567 1568 1569 1570 1571	1572 1573 1574 1575 1576 1577 1578 1579 1580 1581 1582 1583 1584	1585 1586 1587 1588 1589 1590 1591 1592 1593 1594 1595 1596 1597	1598 1599 1600 1601 1602 1603 1604 1605 1606 1607 1608 1609 1610	1611 1612 1613 1614 1615 1616 1617 1618 1619 1620 1621 1622 1623	1624 1625 1626 1627 1628 1629 1630 1631 1632 1633 1634 1635 1636	1637 1638 1639 1640 1641 1642 1643 1644 1645 1646 1647 1648 1649	1650 1651 1652 1653 1654 1655 1656 1657 1658 1659 1660 1661 1662	1663 1664 1665 1666 1667 1668 1669 1670 1671 1672 1673 1674 1675	1676 1677 1678 1679 1680 1681 1682 1683 1684 1685 1686 1687 1688	1689 1690 1691 1692 1693 1694 1695 1696 1697 1698 1699 1700 1701	1702 1703 1704 1705 1706 1707 1708 1709 1710 1711 1712 1713 1714	1715 1716 1717 1718 1719 1720 1721 1722 1723 1724 1725 1726 1727	1728 1729 1730 1731 1732 1733 1734 1735 1736 1737 1738 1739 1740	1741 1742 1743 1744 1745 1746 1747 1748 1749 1750 1751 1752 1753	1754 1755 1756 1757 1758 1759 1760 1761 1762 1763 1764 1765 1766	1767 1768 1769 1770 1771 1772 1773 1774 1775 1776 1777 1778 1779	1780 1781 1782 1783 1784 1785 1786 1787 1788 1789 1790 1791 1792	1793 1794 1795 1796 1797 1798 1799 1800 1801 1802 1803 1804 1805	1806 1807 1808 1809 1810 1811 1812 1813 1814 1815 1816 1817 1818	1819 1820 1821 1822 1823 1824 1825 1826 1827 1828 1829 1830 1831	1832 1833 1834 1835 1836 1837 1838 1839 1840 1841 1842 1843 1844	1845 1846 1847 1848 1849 1850 1851 1852 1853 1854 1855 1856 1857	1858 1859 1860 1861 1862 1863 1864 1865 1866 1867 1868 1869 1870	1871 1872 1873 1874 1875 1876 1877 1878 1879 1880 1881 1882 1883	1884 1885 1886 1887 1888 1889 1890 1891 1892 1893 1894 1895 1896	1897 1898 1899 1900 1901 1902 1903 1904 1905 1906 1907 1908 1909	1910 1911 1912 1913 1914 1915 1916 1917 1918 1919 1920 1921 1922	1923 1924 1925 1926 1927 1928 1929 1930 1931 1932 1933 1934 1935	1936 1937 1938 1939 1940 1941 1942 1943 1944 1945 1946 1947 1948	1949 1950 1951 1952 1953 1954 1955 1956 1957 1958 1959 1960 1961	1962 1963 1964 1965 1966 1967 1968 1969 1970 1971 1972 1973 1974	1975 1976 1977 1978 1979 1980 1981 1982 1983 1984 1985 1986 1987	1988 1989 1990 1991 1992 1993 1994 1995 1996 1997 1998 1999 2000
--	--	--	--	--	--	--	--	--	--	--	--	--	--	--	--	--	--	--	--	--	--	--	--	--	--	--	--	--	--	--	--	--	--	--	--	--	--	--	--	--	--	--	--	--	--	--	--	--	--	--	--	--	--	--	--	--	--	--	--	--	--	--	--	--	--	--	--	--	--	--	--	--	--	--	--	--

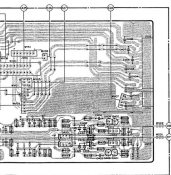
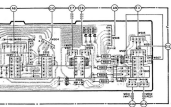

R	0701 0704		0706 0707 0708 0709	
	0701	0704	0706	0707 0708 0709
C	0701 - 0704		0706 - 0709	0701 - 0704
0701-2	0701	0702	0703	0704
0705	0701	0702	0703	0704

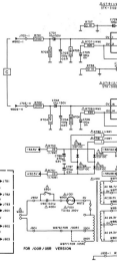
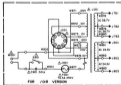

SCHEMATIC DIAGRAM

1000-1001	1002	1003	1004-1005	1006-1007	1008-1009	1010-1011	1012-1013	1014-1015	1016-1017	1018-1019	1020-1021	1022-1023	1024-1025	1026-1027	1028
1029-1030	1031-1032	1033-1034	1035-1036	1037-1038	1039-1040	1041-1042	1043-1044	1045-1046	1047-1048	1049-1050	1051-1052	1053-1054	1055-1056	1057-1058	1059
1060-1061	1062-1063	1064-1065	1066-1067	1068-1069	1070-1071	1072-1073	1074-1075	1076-1077	1078-1079	1080-1081	1082-1083	1084-1085	1086-1087	1088-1089	1090
1091-1092	1093-1094	1095-1096	1097-1098	1099-1100	1101-1102	1103-1104	1105-1106	1107-1108	1109-1110	1111-1112	1113-1114	1115-1116	1117-1118	1119-1120	1121

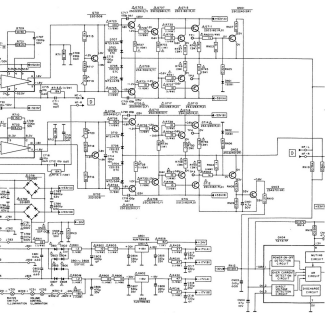

1000	1000	1000	1000	1000	1000	1000	1000
1000	1000	1000	1000	1000	1000	1000	1000
1000	1000	1000	1000	1000	1000	1000	1000
1000	1000	1000	1000	1000	1000	1000	1000
1000	1000	1000	1000	1000	1000	1000	1000
1000	1000	1000	1000	1000	1000	1000	1000

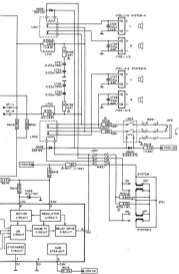

1	
2	100
3-5-7	
6-8	100

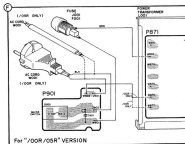
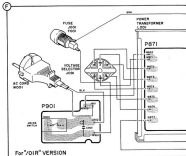

-18-  
**WIRING DIAGRAM**

1000-1010	1011-1020	1021-1030	1031-1040	1041-1050	1051-1060	1061-1070	1071-1080	1081-1090	1091-1100
1101-1110	1111-1120	1121-1130	1131-1140	1141-1150	1151-1160	1161-1170	1171-1180	1181-1190	1191-1200
1201-1210	1211-1220	1221-1230	1231-1240	1241-1250	1251-1260	1261-1270	1271-1280	1281-1290	1291-1300
1301-1310	1311-1320	1321-1330	1331-1340	1341-1350	1351-1360	1361-1370	1371-1380	1381-1390	1391-1400

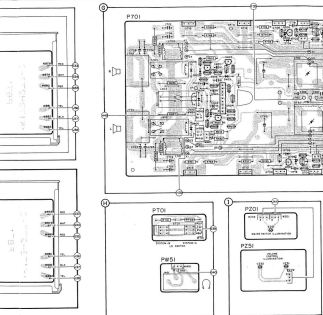





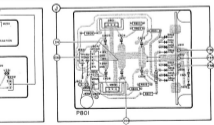
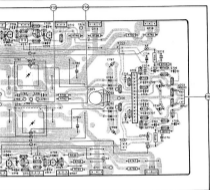











0700-0704	0705-0709	0710-0714	0715-0719	0720-0724	0725-0729	0730-0734	0735-0739	0740-0744	0745-0749	0750-0754	0755-0759	0760-0764	0765-0769	0770-0774	0775-0779	0780-0784	0785-0789	0790-0794	0795-0799
0700-0704	0705-0709	0710-0714	0715-0719	0720-0724	0725-0729	0730-0734	0735-0739	0740-0744	0745-0749	0750-0754	0755-0759	0760-0764	0765-0769	0770-0774	0775-0779	0780-0784	0785-0789	0790-0794	0795-0799
0700-0704	0705-0709	0710-0714	0715-0719	0720-0724	0725-0729	0730-0734	0735-0739	0740-0744	0745-0749	0750-0754	0755-0759	0760-0764	0765-0769	0770-0774	0775-0779	0780-0784	0785-0789	0790-0794	0795-0799
0700-0704	0705-0709	0710-0714	0715-0719	0720-0724	0725-0729	0730-0734	0735-0739	0740-0744	0745-0749	0750-0754	0755-0759	0760-0764	0765-0769	0770-0774	0775-0779	0780-0784	0785-0789	0790-0794	0795-0799
0700-0704	0705-0709	0710-0714	0715-0719	0720-0724	0725-0729	0730-0734	0735-0739	0740-0744	0745-0749	0750-0754	0755-0759	0760-0764	0765-0769	0770-0774	0775-0779	0780-0784	0785-0789	0790-0794	0795-0799



## Idling Current

SEL. SWITCH	SIGNAL	TO	VOLUME	ADJUST	OSCILLOSCOPE	D.C. METER INDICATOR
			Min.	Leh. R719		Leh. TP1(+), TP2(-) DC14mA (20mA) 1
				Reh. R720		Reh. TP3(+), TP4(-) DC14mA (20mA) 1

- 1 Adjust R719 (channel L) or R720 (channel R) so that the voltmeter reads 14 mV about 1 minute after the power has been turned on. (Note that the idling current is about 40 mA after the unit has warmed up.)

 Carbon film 0.125 W or 0.2 W	30°C	5%	 Ceramic plate Tuning <math>\le 120 \mu\text{F}</math> MP.G	2%	$V_b = 2.5 \text{ V}$ $V_c = 3.75 \text{ V}$ $V_d = 5.0 \text{ V}$ $V_e = 7.5 \text{ V}$ $V_f = 10 \text{ V}$ $V_g = 15 \text{ V}$ $V_h = 20 \text{ V}$ $V_i = 30 \text{ V}$ $V_j = 40 \text{ V}$ $V_k = 50 \text{ V}$ $V_l = 100 \text{ V}$ $V_m = 125 \text{ V}$ $V_n = 150 \text{ V}$ $V_o = 160 \text{ V}$ $V_p = 200 \text{ V}$ $V_q = 250 \text{ V}$ $V_r = 300 \text{ V}$ $V_s = 350 \text{ V}$ $V_t = 400 \text{ V}$ $V_u = 500 \text{ V}$ $V_v = 625 \text{ V}$ $V_w = 1000 \text{ V}$ $V_x = 1.5 \text{ V}$ $V_y = 5 \text{ V}$ $V_z = 12 \text{ V}$ $V_{aa} = 15 \text{ V}$ $V_{ab} = 16 \text{ V}$ $V_{ac} = 20 \text{ V}$ $V_{ad} = 50 \text{ V}$ $V_{ae} = 75 \text{ V}$ $V_{af} = 80 \text{ V}$
 Carbon film 0.25 W or 0.33 W	30°C	5%	 Polyester flat foil	10%	
 Metal film 0.25 W or 0.33 W	30°C	5%	 Metalized polyester film	10%	
 Carbon film 0.5 W	30°C	5%	 Polyester flat foil small size (Mylar)	10%	
 Carbon film 0.67 W	70°C	5%	 Polystyrene film/foil	1%	
 Carbon film 1 W or 1.15 W	70°C	5%	 Tubular ceramic		
 Chip component			 Miniature single		
			 Subminiature tanatum	± 20%	

## NOTE:

Some withstand voltages of the condensers are shown in both numerical value and symbol on the circuit diagram. If withstand voltage shown in numerical value is different from that in symbol for a condenser, both are applicable.

Substrat-Layer



087127  
087128  
087129

087130  
087131  
087132  
087133  
087134  
087135  
087136  
087137  
087138  
087139  
087140  
087141  
087142  
087143  
087144  
087145  
087146  
087147  
087148  
087149  
087150  
087151  
087152  
087153  
087154  
087155  
087156  
087157  
087158  
087159  
087160  
087161  
087162  
087163  
087164  
087165  
087166  
087167  
087168  
087169  
087170  
087171  
087172  
087173  
087174  
087175  
087176  
087177  
087178  
087179  
087180  
087181  
087182  
087183  
087184  
087185  
087186  
087187  
087188  
087189  
087190  
087191  
087192  
087193  
087194  
087195  
087196  
087197  
087198  
087199  
087200

0010	4822 426 51142
0020	4822 410 25479
0030	4822 410 24685
0040	4822 412 20987
0060	4822 410 25479
0060	4822 412 20987
0070	4822 412 20985
0080	4822 410 25479
0090	4822 412 20985
0100	4822 404 60345
0110	4822 404 60345
0120	4822 400 60913
0130	4822 410 50157
0140	4822 410 50156
0150	4822 454 40185
0160	4822 404 60341
0180	4822 404 60344
0200	4822 520 51848
0210	4822 458 60375
0220	4822 255 40150
0010,0100	} 4822 426 51143
0110,0120	
0130,0150	
0200	
0250	4822 380 20251
0260	4822 380 20252
0280	4822 454 40157
0310	4822 458 40580
0180	4822 520 51316
0460	4822 452 71455
9070	4822 520 51316
000L	4822 602 12181

Only the mentioned parts are normal service parts

GB

Safety regulations require that the set be restored to its original condition and that parts which are identical with those specified be used.

NL

Veiligheidsvoorschriften vereisen, dat het apparaat in zijn oorspronkelijke toestand wordt teruggevoerd en dat onderdelen, identiek aan de gespecificeerde, worden toegepast.

F

Les normes de sécurité exigent que l'appareil soit remis à l'état d'origine et que soient utilisées les pièces de rechange identiques à celles spécifiées.

D

Bei jeder Reparatur sind die geforderten Ersatzteilenummern zu beachten. Die Originalzustand des Geräts darf nicht verändert werden, für Reparaturen sind Original-Ersatzteile zu verwenden.

I

Le norme di sicurezza esigono che l'apparecchio venga rimesso nelle condizioni originali e che siano utilizzati i pezzi di ricambio identici a quelli specificati.

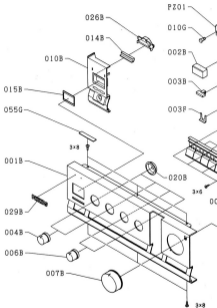

EXPLODED VIEW

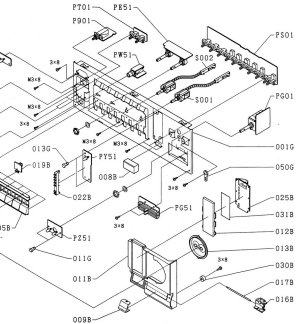

EXPLOD

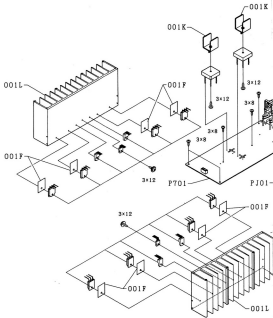

ED VIEW

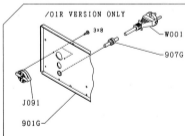
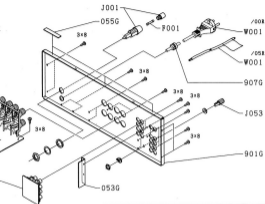



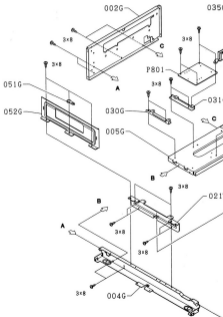

EXPLODED VIEW

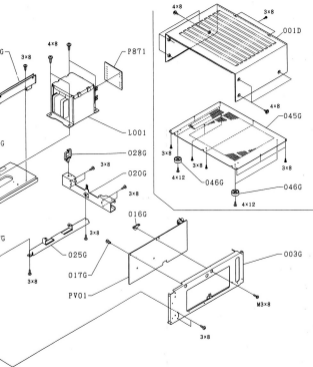

DP01,DA02	155F1	4822 130 3268A
DP03,DA05	DP013C	4822 130 3269B
DP06	152A73	4822 130 3181B
DP07	152A72	4822 130 3265C
DP08-0804	MA18220H	4822 130 3207A
DP09,DP03	151505	4822 130 3181B
DP10-DP17	LN58P0PL	4822 130 3270I
DP18-DP19	852533	4822 130 3208B
DP17,DP19	2amer 3.8 V 1/4 W	4822 130 80132
DP19,DP18	2amer 4.7 V 1/4 W	4822 130 3215B
DP19,DP18	8AV900	4822 130 3266A
DP19-0808	DP151C	4822 130 3268B

DP1,DP04	25C080	4822 130 3262D
DP05	PLM204100	4822 209 8158E
DP01,DA02	25C040	4822 130 4237A
DP02	25A070	4822 130 4264B
DP04	1A7517P	4822 209 8337C
Q401-Q404	25C080H	4822 130 4262B
Q405	PLM204100Z	4822 209 8158E
Q710	25C150B	4822 130 8020D
Q713,Q714	25C0200	4822 130 4232D
Q715,Q716	25A049	4822 130 4264I
Q717,Q718	25C0296	4822 130 8020E
Q719,Q710	25A130B	4822 130 8020H
Q711,Q712	25C2182	4822 130 4266B
Q713,Q714	25A1266	4822 130 4261D
Q715,Q716	25C2182	4822 130 4266B
Q717,Q718	25A1266	4822 130 4261E
Q719	27C0802 M0C3	4822 209 7088B
Q801	SL8075A18A	4822 209 8081E
Q802	SL8075A18A	4822 209 8082D

CB01,CD02	Micro cap.	47 pF	180 V	4822 130 3006B
CB05,CD08	Elect. cap.	180 µF	16 V	4822 130 3203B
CB07,CD09	Elect. cap.	33 µF	16 V	4822 130 3206B
CB09,CD10	Elect. cap.	180 µF	25 V	4822 130 3006C
CD11,CD12	Micro cap.	56 pF	180 V	4822 130 3007B
CD13,CD14	Pol. cap.	0.047 µF	50 V	4822 131 4278E
CD15,CD16	Pol. cap.	0.47 µF	50 V	4822 130 8007I
CD16,CD18	Pol. cap.	0.016 µF	50 V	4822 131 4278F
CD17,CD19	Elect. cap.	5.1 µF	50 V	4822 130 3203C
CD1,CD03	Film cap.	1800 pF	50 V	4822 131 4266I
CD01	Elect. cap.	47 µF	50 V	4822 130 9006B
CD02	Elect. cap.	0.47 µF	50 V	4822 130 8007I
CD04,CD05	Elect. cap.	47 µF	10 V	4822 130 8008F
CD07,CD08	Film cap.	0.047 µF	50 V	4822 131 4276A
CD09,CD10	Film cap.	0.012 µF	50 V	4822 131 4276D
CD11,CD12	Pol. cap.	1800 pF	50 V	4822 131 4276E
CD13,CD14	Elect. cap.	33 µF	16 V	4822 130 8004B
CD15,CD16	Pol. cap.	0.001 µF	50 V	4822 131 4276G
CD17,CD18	Elect. cap.	330 µF	25 V	4822 130 2100D
CD17,CD19	Elect. cap.	47 µF	6.3 V	4822 130 2100E
CD19,CD20	Elect. cap.	15 µF	16 V	4822 130 2100F
CD11,CD12	Film cap.	1500 pF	50 V	4822 131 4276H
CD13,CD14	Elect. cap.	100 µF	16 V	4822 130 8005B
CD15,CD16	Film cap.	0.02 µF	50 V	4822 131 4276H
CD17,CD18	Elect. cap.	100 µF	50 V	4822 130 2117I
CD18,CD19	Car. cap.	0.01 µF	500 V	4822 132 3264D
CD19,CD20	Elect. cap.	8000 µF	80 V	4822 130 2217G
CD17,CD18	Elect. cap.	100 µF	80 V	4822 130 2217I
CD04,CD07	Elect. cap.	330 µF	25 V	4822 130 9005D
CD05,CD08	Elect. cap.	220 µF	25 V	4822 130 9004B
CD06	Elect. cap.	470 µF	25 V	4822 130 2204D
CD01	Car. cap.	0.01 µF	480 V	4822 132 4268B

FE21,FE22	Var. res.	500 Ω	1/4 W	4822 111 9108B
FE23,FE25	Fixed res.	47 Ω	1/4 W	4822 111 9017I
FE26,FE30	Poten. band/ trimp.	10 kΩ		4822 100 2057A
FE05	Poten. vol.	50 kΩ		4822 100 2057E
FE07	Poten. vol.	180 kΩ		4822 100 1006B
FE01,FE02	Res.	1 kΩ	1/4 W	4822 111 4127G
FE11	Res.	22 Ω	1/4 W	4822 110 8019E
FE17	Res.	180 Ω	1/4 W	4822 111 9017D
FE07,FE10	Res.	330 Ω	1/4 W	4822 110 8020K
FE15,FE09	Res.	2.2 Ω	1/4 W	4822 110 5379I
FE07	Res.	880 Ω	1/2 W	5322 110 5408B
FE11	Res.	2.2 kΩ	1/4 W	4822 110 5379I
FE11,FE12	Res.	3.3 kΩ	1/4 W	4822 110 5113F
FE15	Res.	200 Ω	1/4 W	4822 110 8009A
FE11,FE14	Res.	4.84 kΩ	1/4 W	4822 110 5269I
FE27,FE28	Res.	47 kΩ	1/4 W	4822 111 9017I
FE29,FE30	Fixed res.	820 Ω	1/4 W	4822 110 8004D
FE13,FE14	Res.	18 kΩ	1/4 W	4822 111 9126B
FE16,FE17	Trimmer	2.2 kΩ		4822 100 2053B
FE18,FE19	Res.	100 Ω	1/4 W	4822 111 9126B
FE17,FE18	Var. res.	1.2 kΩ	1/4 W	4822 111 9126F
FE19,FE20	Var. res.	10 Ω	1/4 W	4822 111 9126I
FE21,FE22	Res.	3.3 Ω	1/4 W	4822 110 5304E
FE23,FE24	Res.	150 Ω	1/4 W	4822 110 5304E
FE25,FE26	Res.	0.18 Ω	1/4 W	4822 110 8015D
FE11,FE12	Var. res.	22 Ω	1/4 W	4822 111 9126B
FE13,FE14	Var. res.	220 Ω	1/4 W	4822 111 9080D
FE15,FE16	Var. res.	10 Ω	1/4 W	4822 111 9072E
FE17,FE18	Fixed res.	1 Ω	1/4 W	4822 110 5303B
FE19,FE20	Res.	1.2 Ω	1/4 W	5322 110 5328D
FE01,FE02	Poten. res.	10 Ω	1/4 W	4822 110 8018E
FE03,FE06	Res.	10 Ω	1/4 W	4822 111 4127I
FE07	Poten. res.	180 Ω	1/4 W	4822 110 8020F
FE08	Res.	33 Ω	1/4 W	4822 110 5029A

Miscellaneous		
FE01	Fuse T5,15A	4822 203 3002F
FA01-FA08	Female con.	4822 200 1006B
JB1	Socket	4822 200 2051C
JB2	Socket	4822 200 4058I
JB3	Connector	4822 200 3028D
JB4	Connector	4822 200 3028E
JW01	Jack headphone	4822 207 3061I
JB1	Fuse holder	4822 200 3003D
JB5	Socket	4822 200 1002B
JB6	Connector	4822 200 3002D
J701	Connector loading	4822 200 3002I
J702	Connector loading	4822 200 3007I
LA01,LA02	Protection relay	4822 200 3007I
LY02	Filter 24 V	4822 200 2019B
LD01	CO-direct relay	4822 200 3019E
LD02	Poten. transformer	4822 140 2121B
LT01,LT02	Choke coil	4822 127 5175B
SD01	Switch touch/reset	4822 270 4940Z
SD02	Switch monitoring/stop	4822 270 4940I
SD03	Switch CO-direct	4822 270 2044D
SD04	Switch speaker	4822 270 2044D
SD01,SD02	Switch stop	4822 277 2040D
SD01	Switch input set	4822 270 2025A
SD02	Switch rec. mode set	4822 270 8022D
SD03	Switch power	4822 270 1105I
YV11,YV21	Lamp 8 V 50 mA	4822 130 4079I
YV21,YV22		

5.  
 Korrektur der Liste mechanischer  
 Teile (Serv.Manual S. 18):

Pos. 031B (4022 400 40588) muß  
 richtig heißen 4022 400 10002.

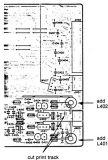

out print track

Fig. 1



Fig. 2

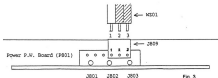

Fig. 3